

MICHAELANASTASSIADES

INSTALLATION INSTRUCTIONS

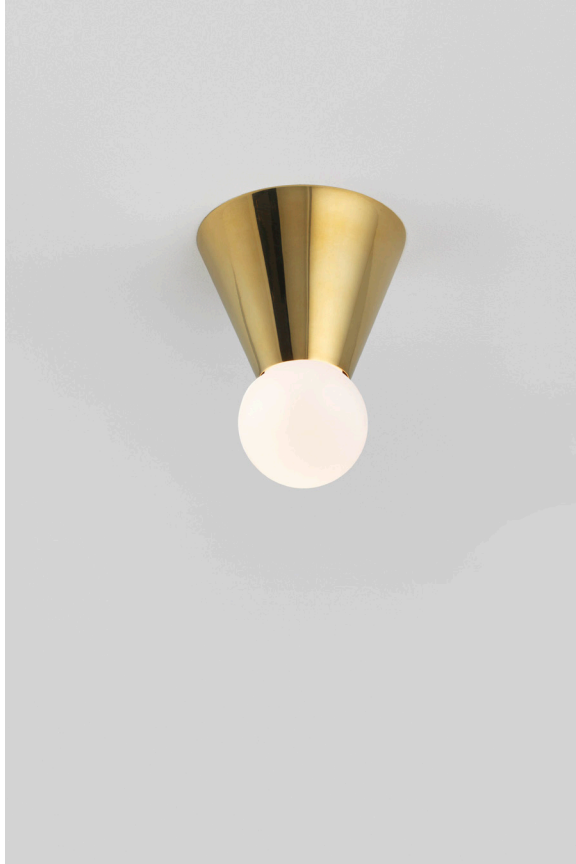

CONE LIGHT
CEILING & WALL MOUNTED, 2013

PRODUCT SPECIFICATIONS

Input voltage: 120V / 240V
G9 Maximun wattage 25W
120V / 240V dimmable LED triac
Product weight: ~1kg

120V version supplied with paintable junction box cover.

BEFORE INSTALLING

Please keep these instructions for future reference.

Please read instructions in full prior to installation noting all illustrations. Instructions should be followed precisely.

Always wear the gloves provided when handling the fixture.

If you are in any doubt, consult a qualified electrician to install the fitting.

Install in accordance with current national or local wiring regulations.

Ensure the circuit, to which the fitting is to be connected, has been installed and fused in accordance with local electrical standards.

Disconnect the electrical supply at the fuse box. Switching off via a wall switch is not adequate.

Ensure that only the correct types of bulbs are fitted. Before changing light bulbs, always switch off the mains power and allow the lamp to cool.

The fitting is for use in a normal dry domestic indoor environment. Suitable for mounting on non-combustible surfaces only.

If removing an existing fitting, carefully note all wiring connections and record which of the wires is connected to which terminal.

Carefully identify the supply cable. Check there are no other cables in the area to avoid damage to concealed wiring during installation.

Please make sure the wires are matching to the correct connectors according to live, neutral or earth (ground).

Position the light where desired, ensuring that the area is suitable to support the weight of the light.

Determine the fixing method appropriate to the surface material.

Modifying any part of the light will void the products warranty.

Michael Anastassiades accepts no liability for incorrect use of the mentioned object.

CLEANING INSTRUCTIONS

Before cleaning, lighting fixtures must be turned off and unplugged from mains electricity. Whilst cleaning please take care and use the gloves provided.

Polished brass: As the item is unlacquered it will naturally oxidise and darken. Upon touching the items without gloves, fingerprints are likely to occur and leave marks. Use a good quality brass cleaning liquid and follow the product instructions using the extra soft dust cloth. Do not apply pressure on persistent marks. Remove them using repeated gentle motions and by reapplying the brass cleaning liquid.

Polished nickel: Use a lightly damp soft dust cloth and gently go over marks until clean. Dry it afterwards with a soft dust cloth. Make sure the product is completely dry before switching the electricity on.

Black patinated: Use a dry soft dust cloth and gently go over marks until clean.

Glass diffuser: Remove the glass diffuser from the product. Using a lightly damp cloth, clean only the outside of the sphere. Only put the glass sphere back on the product once it is fully dry.

Parts Supplied

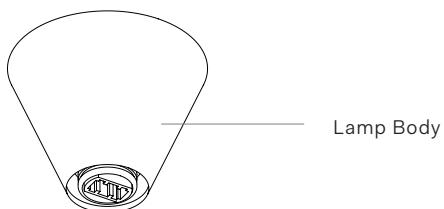
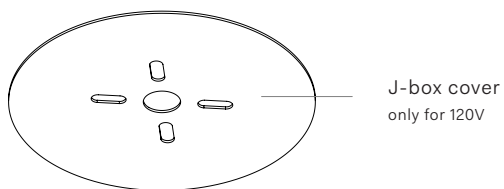
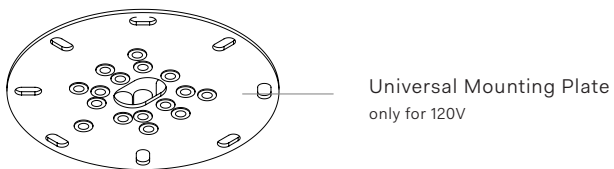

Additional Items Provided

Pair of Gloves
Spare Kit Bag

Additional Requirements

Power Drill and Bits
Mounting Screws and Ceiling Anchors

Fig. 1

Whilst installing the fixture please take care and use the gloves provided.

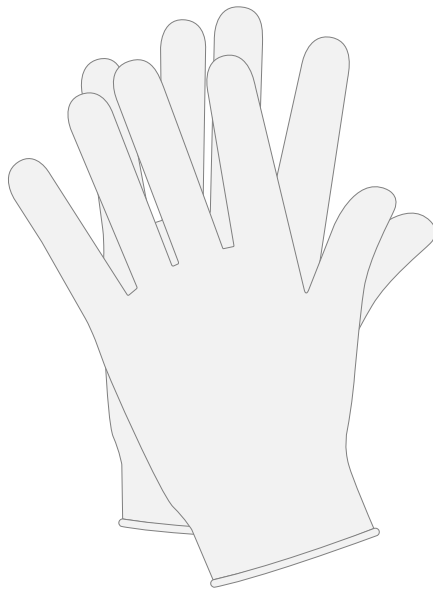

Fig. 2

Unscrew in order to separate the main body (C) from the backplate (D).

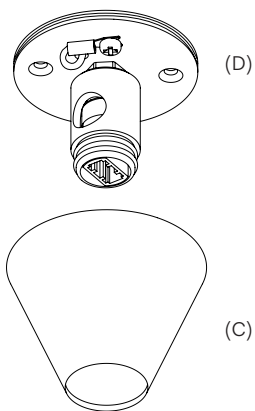
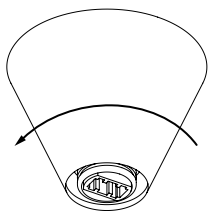

Fig. 3 For 240V Fittings

Place the back plate (D) onto the wall, centre it to the mains electrical supply cable and mark two holes to be drilled. Once drilled, insert wall anchors into the holes, ensuring that the area is able to support the entire weight of the fixture (noted on product specification). Screw the back plate onto the wall, making sure it is levelled.

Wall anchors and mounting screws are not supplied for this fixture. Determine the fixing method appropriate to the surface material before starting the project. Use fixings that are suited to the surface material and are sufficient to bear the weight of the light.

Connect the live, neutral and earth of the mains electrical cable to the terminal block of the fixture. Make sure all electrical cables match correctly.

See Cable Connection Guide for further reference.

Go to Fig. 6 for next step.

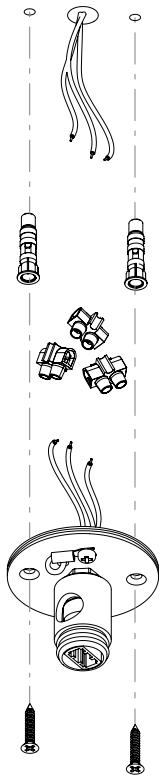

Cable Connection Guide

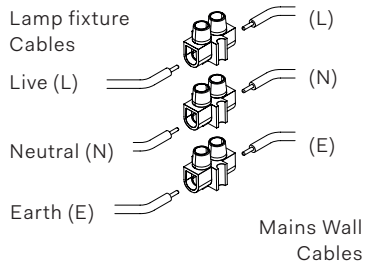
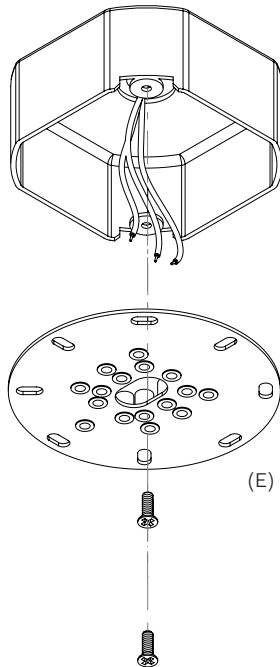

Fig. 4 For 120V Fittings

Screw the Universal Mounting Plate (E) onto the junction box, making sure it is levelled. Pull live, neutral and ground cables out through the central hole. Mounting screws are not supplied with this fixture as J-boxes can vary.



Note - Make sure the supplied Universal Mounting Plate is fastened directly to the junction box. The surface of the junction box should be set back 1/8" or 3mm from the mounting surface. This will ensure the best possible fit for ease of installation and final finish. Note below the correct and incorrect fit for optimum installation.

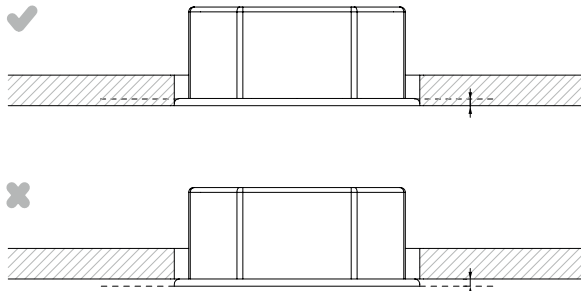

Fig. 5 For 120V Fittings

Feed the electrical cables through the central hole of the Junction box cover (F) and the backplate (D). Use screws supplied (G) to secure the light to the J-Box.

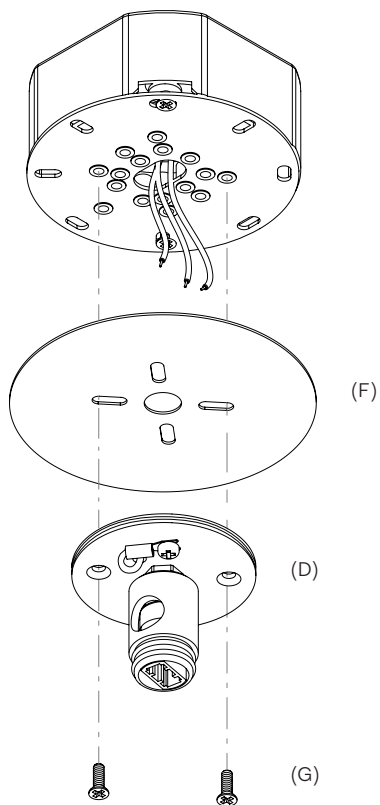

Fig. 6

Screw the main body (C) to the backplate (D).

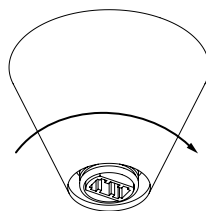
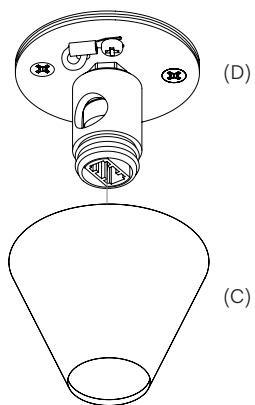
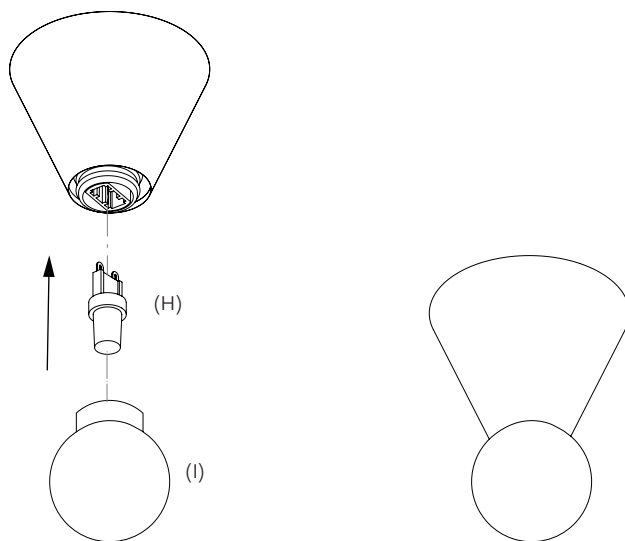

Fig. 7

Insert the G9 bulb (H) into the lamp holder. Insert the glass diffuser (I).



Michael Anastassiades' design philosophy is to preserve the inherent qualities of given materials. All of our products are handmade and come in natural finishes, exposed to the elements without any protective lacquers. We look at oxidisation as part of a process that adds to the patina of an object, increasing beauty with time. We try our best for all goods to leave our premises in pristine condition, but sometimes products may arrive with minor oxidisation marks.

Whilst every effort is made to ensure an accurate representation of product colours, finishes and dimensions, Michael Anastassiades Ltd reserves the right to alter these details without notice, in compliance with its own production needs, technological changes or in response to the current market needs. Colour swatches are for reference only; Michael Anastassiades Ltd cannot guarantee exact colour match for any product finishes.

All designs are protected under copyright law. Michael Anastassiades holds the exclusive manufacturing and distribution rights worldwide. Copying will be prosecuted.

All light fixtures in this catalogue have CE marking compliance.

Michael Anastassiades Ltd.
50 Rochester Place, London NW1 9JX
T +44 (0)20 7928 7527
sales@michaelanastassiades.com
www.michaelanastassiades.com
© 2020 Michael Anastassiades Ltd. All rights reserved.